



GS4/N - Lincat Silverlink 600 Natural Gas Counter-top Griddle - Steel Plate - W 450 mm - 5.4 kW

Whether you're cooking eggs, bacon, burgers or vegetables, the versatile Silverlink 600 Gas Griddle won't let you down.

- ✓ 12 mm v machined steel plate providing even heat distribution and an easy to clean surface
- ✓ Front mounted control for easy of use during cooking
- ✓ Thermostatically controlled to give accurate temperatures during the cooking process for consistent results
- ✓ Piezo ignition for easy lighting of the burners
- ✓ The plate is fully welded into the frame to prevent leaks and places where food and carbon can build up
- ✓ Flame failure device for maximum safety

Specifications

Summary

Brand	Lincat
Range	Silverlink 600
Power Type	Gas
Gas Type	Natural Gas
Unit Type	Counter-top
Available in UK Only	No
UK Warranty	2 Years Parts and Labour Warranty
Export Warranty	Contact your local dealer
GTIN	5056105104780

Power and Performance

BTU per Hour	18,425
Total Power kW	5.4
Cooking Area (Width x Depth) mm	412 x 405
Temperature Control	Mechanical

Key Specifications

Number of Heat Zones	2
Grill Plate Surface Type	Smooth
Grill Plate Material	Steel

Weights and Dimensions

Unit Height (External) mm	415
Unit Width (External) mm	450
Unit Depth (External) mm	650
Net Weight Kg	35.1

Supply Connections

Requires Installation	Yes
Requires Electrical Supply	No
Gas Connection BSP	1/2"
Gas Consumption at full rate Natural m³ per Hour	0.51
Gas Pressure Natural mbar	16.0
Total heat input at full rate Natural kW	5.4
Total heat input at full rate Natural BTU per hour	16,700

Shipping

Packed Weight Kg	38.61
Packed Height cm	63.5
Packed Width cm	70
Packed Depth cm	55

Available Accessories

CH01	Caterflex Hose 1/2" - 1 Metre - for use with units up to 66,000 BTU
CH02	Caterflex Hose 1/2" - 1.5 Metre - for use with units up to 56,000 BTU

Available Accessories

CN4	Lincat Silverlink 600 Free-standing Ambient Open-Top Pedestal without Doors - W 450 mm
SB4	450 GRIDDLE SPLASHB
SLS4	Lincat Silverlink 600 Free-standing Floor Stand - for units W 450 mm

Technical Picture

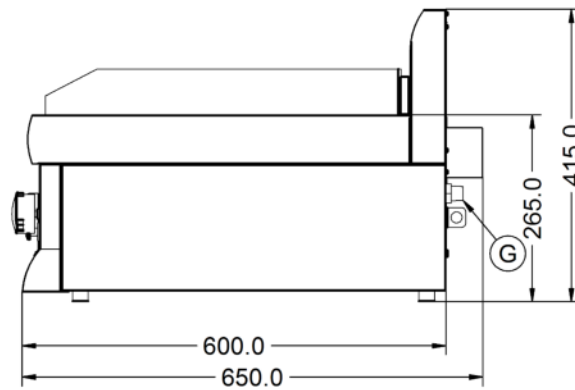
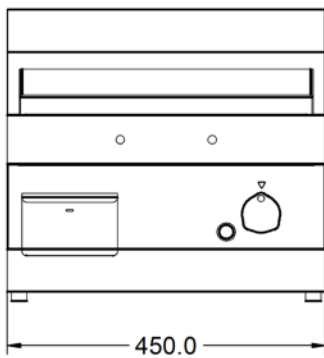
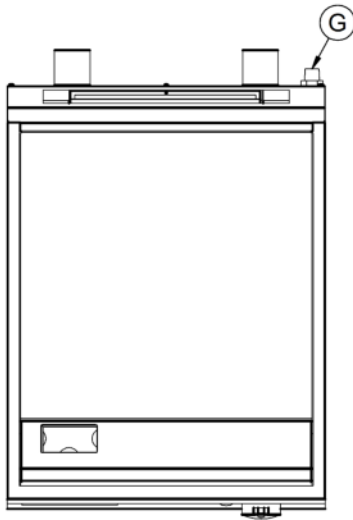



Lincat Limited

Whisby Road,
Lincoln, LN6 3QZ,
United Kingdom

Company No: 2175448

A member company of



Customer Care

Tel: +44 1522 875500
Email: care@lincat.co.uk

Export Customers

Tel: +44 1522 875536
Email: export@lincat.co.uk

Opening Hours

Monday – Friday:
8.30am – 5pm