



# Installation, Operating, Servicing and Conversion Instructions

## Silverlink 600 Gas Boiling Tops HT3, HT6 & HT9

Please make a note of your product details for future use:

Date Purchased: \_\_\_\_\_

Model Number: \_\_\_\_\_

Serial Number: \_\_\_\_\_

Dealer: \_\_\_\_\_

\_\_\_\_\_

**SILVERLINK 600**

# CONTENTS

|  |    |
|--|----|
| Important Information                            | 2  |
| Warnings and Precautions                         | 3  |
| Technical Data                                   | 4  |
| Checklist of Enclosures                          | 5  |
| Installation and Commissioning                   | 6  |
| Operating Instructions                           | 8  |
| Cleaning   | 9  |
| Servicing, Maintenance and Component Replacement | 10 |
| Conversion                                       | 11 |
| Fault Finding                                    | 13 |
| Spare Parts List                                 | 14 |
| Accessories                                      | 15 |
| Service Information and Guarantee                | 16 |

## IMPORTANT INFORMATION



Read these instructions carefully before using this product, paying particular attention to all sections that carry warning symbols, caution symbols and notices. Ensure that these are understood at all times.



### **WARNING!**

This symbol is used whenever there is a risk of personal injury.



### **CAUTION!**

This symbol is used whenever there is a risk of damaging your Lincat product.

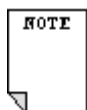

### **NOTE:**

This symbol is used to provide additional information, hints and tips.

**KEEP THIS MANUAL FOR FUTURE REFERENCE**

## WARNINGS AND PRECAUTIONS



This appliance must be installed, commissioned, serviced and converted by a qualified person in accordance with national and local regulations in force in the country of installation.

Strip plastic coating and clean the appliance before use.

During operation parts may become hot - avoid accidental contact.

Parts protected by the manufacturer shall not be adjusted by the user.

Do not obstruct or block the flue.

Installation must include sufficient ventilation to prevent the occurrence of unacceptable concentrations of substances harmful to health in the room in which they are installed.

After operation, some parts of the appliance will remain hot for a period of time. Please take care to avoid accidental burns.

# TECHNICAL DATA

| Model                            | HT3                           | HT6    | HT9    |
|----------------------------------|-------------------------------|--------|--------|
| Overall Height (mm)              | 305                           |        |        |
| Width (mm)                       | 300                           | 600    | 900    |
| Depth (mm)                       | 600                           |        |        |
| Weight (kg)                      | 16                            | 28     | 32     |
| Total Heat Input Natural (Gross) | 9.0kW                         | 18.0kW | 27.0kW |
| Total Heat Input Propane (Gross) | 9.0kW                         | 18.0kW | 27.0kW |
| Total Heat Input Butane (Gross)  | 7.4kW                         | 14.8kW | 22.2kW |
| Gas Inlet Connection             | 1/2" BSP (R <sub>p</sub> 1/2) |        |        |
| Supply Pressure - Natural        | 20mbar                        |        |        |
| Supply Pressure - Propane        | 37mbar                        |        |        |
| Supply Pressure - Butane         | 28-30mbar (29mbar)            |        |        |

## Individual Burner Heat Input Full Rate

|         |       |
|---------|-------|
| Natural | 4.5kW |
| Propane | 4.5kW |
| Butane  | 3.7kW |

## Individual Burner Heat Input Low Rate

|         |        |
|---------|--------|
| Natural | 0.85kW |
| Propane | 0.85kW |
| Butane  | 0.85kW |

## Gas Consumption Full Rate

|                          |                                    |                                    |                                    |
|--------------------------|------------------------------------|------------------------------------|------------------------------------|
| Total Gas Rate – Natural | 0.86m <sup>3</sup> h <sup>-1</sup> | 1.72m <sup>3</sup> h <sup>-1</sup> | 2.57m <sup>3</sup> h <sup>-1</sup> |
| Total Gas Rate – Propane | 0.64kgh <sup>-1</sup>              | 1.29kgh <sup>-1</sup>              | 1.93kgh <sup>-1</sup>              |
| Total Gas Rate – Butane  | 0.54kgh <sup>-1</sup>              | 1.08kgh <sup>-1</sup>              | 1.62kgh <sup>-1</sup>              |

## Individual Burner Gas Consumption Full Rate

|                    |                                    |
|--------------------|------------------------------------|
| Gas Rate – Natural | 0.43m <sup>3</sup> h <sup>-1</sup> |
| Gas Rate – Propane | 0.32kgh <sup>-1</sup>              |
| Gas Rate – Butane  | 0.27kgh <sup>-1</sup>              |

## Gas Consumption Low Rate

|                          |                                    |                                    |                                    |
|--------------------------|------------------------------------|------------------------------------|------------------------------------|
| Total Gas Rate – Natural | 0.16m <sup>3</sup> h <sup>-1</sup> | 0.32m <sup>3</sup> h <sup>-1</sup> | 0.49m <sup>3</sup> h <sup>-1</sup> |
| Total Gas Rate – Propane | 0.12kgh <sup>-1</sup>              | 0.24kgh <sup>-1</sup>              | 0.36kgh <sup>-1</sup>              |
| Total Gas Rate – Butane  | 0.12kgh <sup>-1</sup>              | 0.25kgh <sup>-1</sup>              | 0.37kgh <sup>-1</sup>              |

## Individual Burner Gas Consumption Low Rate

|                          |                                    |
|--------------------------|------------------------------------|
| Total Gas Rate – Natural | 0.08m <sup>3</sup> h <sup>-1</sup> |
| Total Gas Rate – Propane | 0.06kgh <sup>-1</sup>              |
| Total Gas Rate – Butane  | 0.06kgh <sup>-1</sup>              |

## CHECK LIST OF ENCLOSURES

| <b>Model</b>      | <b>HT3</b> | <b>HT6</b> | <b>HT9</b> | <b>Tick</b> |
|-------------------|------------|------------|------------|-------------|
| Warranty Card     | 1          | 1          | 1          |             |
| Pan Supports      | 1          | 2          | 3          |             |
| User Instructions | 1          | 1          | 1          |             |

# INSTALLATION AND COMMISSIONING

Site this appliance beneath an extraction canopy for the removal of combustion products.

Installation must include sufficient ventilation to prevent the occurrence of unacceptable concentrations of substances harmful to health in the room of installation. There must be a minimum free area of 4.5cm<sup>2</sup> per kW of total heat input.

Allow for a sufficient flow of fresh air for complete gas combustion.

Do not connect directly to any flue, ducting or mechanical extraction system.

The gas supply hose or tubing shall comply with national requirements in force and shall be periodically examined and replaced as necessary.



An equipotential bonding terminal is provided to allow cross bonding with other equipment.

Install this appliance on a level surface ensuring all vents are unobstructed. Any partitions, walls or furniture must be of non-combustible material and not be closer than 50mm

Ensure there is a space of at least 1000mm between the working surface and any ceiling.

## GAS SUPPLY AND CONNECTION

Connection is at the rear of the unit via a R<sub>p</sub>1/2 (1/2" BSP)

When making the connection to the appliance an isolating cock should be fitted into the supply line close to the unit, for emergency shutdown or servicing purposes.

## SUPPLY PRESSURES

The appliances are intended to be connected directly to the gas supply without further adjustment for those countries where the supply pressure does not exceed the pressures as detailed above. For those countries where the supply pressures exceed the pressures as tabled then the supply pressure must be regulated to the pressures as detailed above. For the purposes of proving connection integrity access to the pressure test nipple is as follows:



- To gain access to the gas pressure test nipple open the oven door/s.
- Remove the control knobs.
- Remove the anti-tamper screws securing the fascia
- Remove the oven ignitor lead.
- The test nipple is found on the manifold rail.

## FIRST TIME LIGHTING

The procedure for first time lighting may only be carried out by registered personnel.

To light any individual burner it may be necessary to purge all pipe work of air.

To do this, depress and hold in the full on position as many controls knobs as possible until there is evidence of free gas flow. Upon detection of gas flow return all but one control knobs to the 'OFF' position and light the gas at the burner corresponding to the control

knob in the depressed position. When the gas at the burner is burning correctly shut it down and repeat the lighting process for the remaining burners.

It is not recommended that a boiling top unit be sited adjacent to either a counter top fryer or a free standing fryer.

### **COUNTER TOP**

If the appliance is to be installed on a counter top it shall be of a sturdy construction to hold the weight of the appliance.

The counter top shall be of a non-combustible material.

The appliance when installed on a suitable countertop shall be level.

### **FLOOR STAND AND PEDESTALS**

The appliance can be fitted to its corresponding floor stands and pedestals.

# OPERATING INSTRUCTIONS

Only qualified or trained personnel should use this appliance.

## LIGHTING SEQUENCE

Please ensure that the gas isolation valve for the appliance is turned to the open position before attempting to light this unit.

### Hob Burners

From the OFF position: press and turn the control knob anti-clockwise to any position between the two stylized flames to allow gas through to the burner.

Maintaining the control knob depressed, manually light the gas at the burner using a taper or piezo ignitor wand.

On establishing a flame at the burner, keep the knob depressed for approximately 15 seconds then release. The burner should remain lit.

If the appliance has stood unused for any length of time it may be necessary to purge the burner feed pipes of air. To purge the burner feed pipes of air depress and rotate a control knob to the full on position. Maintain the knob in the depressed position for 20-30seconds and then light the gas at the burner. Repeat as necessary until the gas ignites.

## USING THE APPLIANCE

Ensure the pan supports are centrally placed on the hob to.

It is recommended that a burner is lit first before placing large pans over the burner.



It is not recommended that multiple lit burners are covered at any one time by large gastronome pans or detachable griddle plates.

### PAN PLACEMENT

Pans should be placed centrally on the pan support in relation to the burner for maximum efficiency.

### PAN SIZES

The recommended pan base diameters are no smaller than 150mm and no larger than 400mm.

Pans should never be placed in such a position that they become a hazard from tipping

## OPERATION OF THE APPLIANCE

- The appliance should not be left unattended when in use for any lengthy period of time.
- Pans should only be filled to a level no more than to prevent a boil over situation.
- Periodically inspect liquid volumes to prevent a boil dry situation.
- Frying of product should never be left unattended.
- Use hand and arm protective when handling hot pans to avoid injuries from burns.



# CLEANING



Do not use a water jet or steam cleaner, and do not immerse this appliance.

Clean all panels with warm water and mild detergent, do not use abrasive materials. Dry with a soft cloth.

It is important that users of the appliance systematically check and clean down as necessary areas of the hob and oven cavity that have accumulated oils, fats and other combustible debris from previous cooking. Particular attention must be paid to the burner head ports. Ensure they are always clear. Ensure the appliance and all its parts are in a cold state before commencing any cleaning routine.

Areas to Check

- **Burner Caps** – Check burner caps are clean and centrally seated on the burner head
- **Burner Heads** – The burner heads can only be fitted in one orientation onto the burner body. As a guide the recess with the two ports aligns with the thermocouple.
- **Pan Supports** – The pan supports are manufactured from cast iron and are heavy. For ease of cleaning they can be removed from the appliance and placed in a suitable dish washer.

# SERVICING, MAINTENANCE AND COMPONENT REPLACEMENT

To access parts internally remove the control knobs. Remove the fascia panel securing screws from the underside of the fascia panel.

## Burner Components

To replace the burner and its parts:

- Remove the burner cap 'BU09'
- Remove the burner head 'BU08'
- Remove the 3 screws 'FAS601'
- Remove the control knobs from the valves
- Remove the fascia panel
- Loosen the burner feed pipe connection nut on 'CO15'
- Loosen the thermocouple nut 'TC01' connection at the corresponding valve
- Remove the burner body 'BU07' and the gasket 'FAS351'
- Remove the injector 'JExx' (dependent on gas type) from the burner body
- Remove the thermocouple 'TC01' from the burner body
- Remove the remain parts of 'CO15' from the burner body
- Replace and reassemble any or all parts as applicable

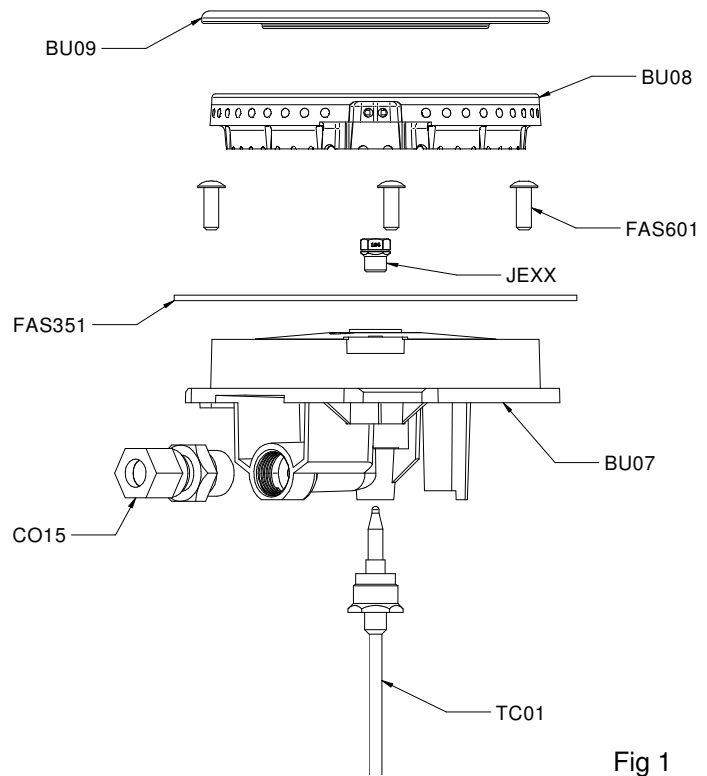

## Valve Components

To remove the valve and its parts:

- Remove the control knobs
- Remove the fascia panel
- Loosen the thermocouple 'TC01' nut at the valve body 'VA10'
- Loosen the burner feed pipe nut 'BU159' at the valve
- Remove the valve clamp screw 'BU209'
- Lift the valve clamp 'BU208' from the valve and the manifold 'MAxx' (dependent on appliance)
- Free the valve from the manifold
- Replace and reassemble parts as necessary
- Perform leak test to prove integrity of joints

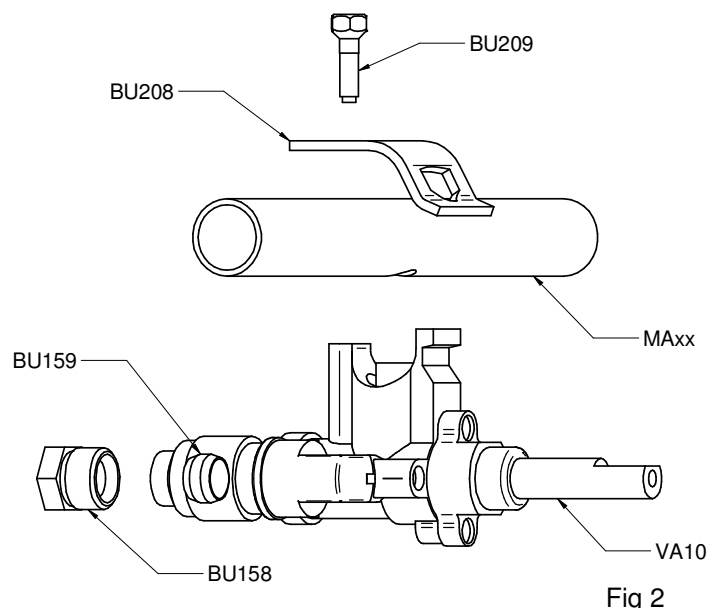

# CONVERSION

## CONVERSION OF GAS TYPE

### Burner Injector Changes

| Model | Gas | Inlet Pressure | Ø    | Mark | Part Number |
|-------|-----|----------------|------|------|-------------|
| All   | G20 | 20mbar         | 1.64 | 164  | JE155       |
|       | G30 | 28-30mbar      | 0.98 | 98   | JE157       |
|       | G31 | 37mbar         | 1.10 | 110  | JE156       |

### Conversion from One Gas Type to Another

To convert the appliance from one gas type to another it will be necessary to replace the main burner injectors

Ensure the appliance for conversion and all its parts are in a 'cold' state

Remove the pan support(s) for ease of access

Remove the burner caps and burner heads

Remove and replace the burner injectors as detailed below applicable to the gas type required.

Replace gas specific labels for which the appliance has been converted

Replace data plate corresponding to gas type

### Burner Injector

The burner injector is fitted to the base of the burner body

Remove the burner cap 'BU09'

Remove the burner head 'BU08'

Access to the burner injector 'JExx' is through the venturi to the base of the burner body 'BU07'. To remove un-screw by turning anticlockwise

The correct size of the injector appertaining to gas type is marked on one of the hexagonal faces of the injector.

Replace with the correct injector applicable to gas type and reassemble burner parts

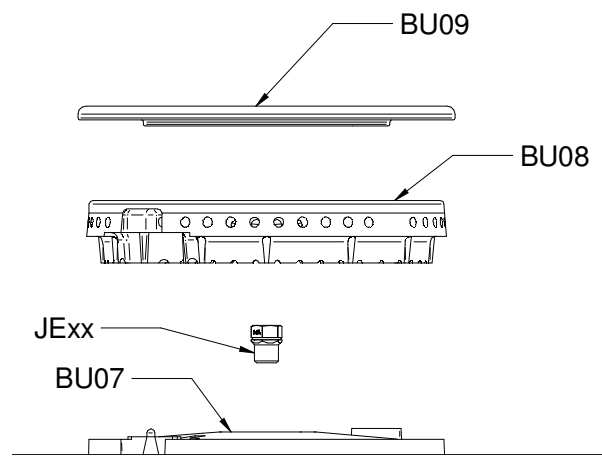

Fig 3

## Bypass Injector Adjustment

Remove the control knobs

Adjustment for conversion from Natural gas to Propane or Butane:

Rotate the bypass injector clockwise full home, do not over tighten.

Replace the control knobs

Adjustment for conversion from Propane or Butane to Natural gas :

Ensure the bypass injector is fully home, do not over tighten

Rotate the bypass injector between 1/3 to 1/2 of a turn anticlockwise

Replace the control knobs

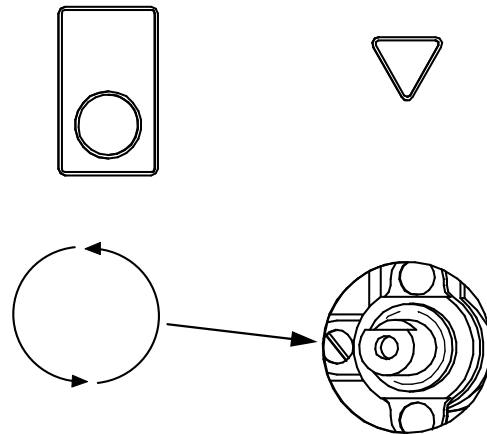
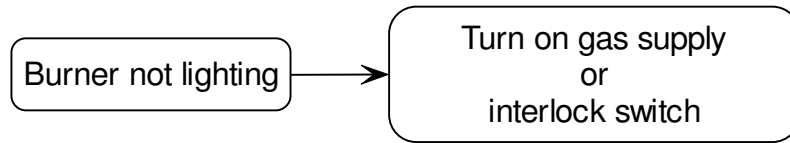

Fig 4

# FAULT FINDING

## Burner not lighting



## Not all burner ports are lit

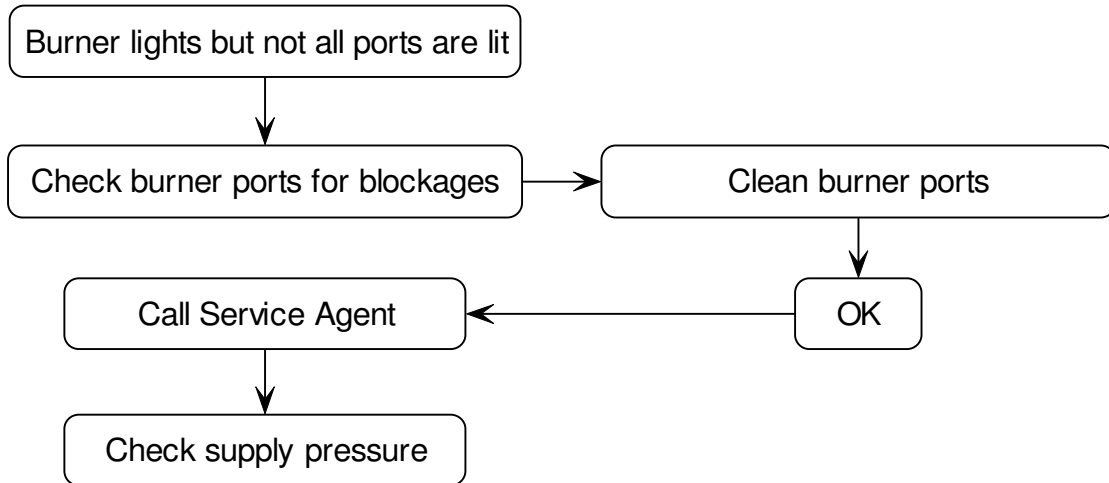

Note: Gas not burning at all the burner ports can occur after a spillage or boil over where water has collected in the burner ports.

## Burners will not remain lit

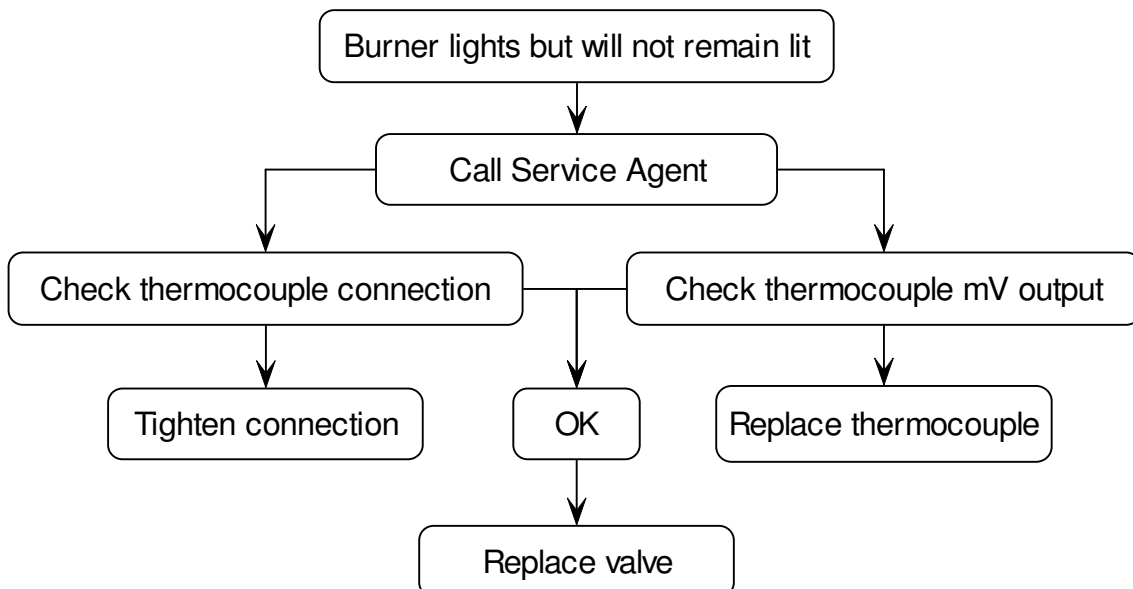

## SPARE PARTS LIST

| <b>Part number</b> | <b>Part description</b> | <b>Used on</b> |
|--------------------|-------------------------|----------------|
| BU07               | Burner Body             | All            |
| BU08               | Burner Head             | All            |
| BU09               | Burner Cap              | All            |
| TC01               | Thermocouple            | All            |
| FAS351             | Burner Gasket           | All            |
| JE155              | Natural Gas Injector    | All            |
| JE156              | Propane Gas Injector    | All            |
| JE157              | Butane Gas Injector     | All            |
| PA25               | Pan Support             | All            |
| MA140              | Manifold                | HT3            |
| MA141              | Manifold                | HT6            |
| MA141              | Manifold                | HT9            |
| VA10               | Valve                   | All            |
| BU158              | VA10 Tube Nut           | All            |
| BU159              | VA10 Olive              | All            |
| BU208              | VA10 Clamp Bracket      | All            |
| BU209              | VA10 Clamp Screw        | All            |
| KN196              | Control Knob            | All            |
| CO15               | Compression Fitting     | All            |
| TU13601            | Front Burner Pipe       | All            |
| TU13602            | Rear Burner Pipe        | All            |

# ACCESSORIES

| Part Number | Description | Used on |
|-------------|-------------|---------|
| HT6/SB      | Splash Back | HT6     |
|             |             |         |
|             |             |         |
|             |             |         |

## SERVICE INFORMATION

For help with the installation, maintenance and use of your **Lincat** equipment, please contact our service department:

**☎ UK: 01522 875520**

For non-UK customers, please contact your local Lincat dealer

All service work, other than routine cleaning should be carried out by one of our authorised service agents. We cannot accept responsibility for work carried out by other persons.

To ensure your service enquiry is handled as efficiently as possible, please tell us:

- Brief details of the problem
  - Product code
  - Type number
  - Serial number
- } All available on serial plate

Lincat reserve the right to carry out any work under warranty, given reasonable access to the appliance, during normal working hours, Monday to Friday, 08:30 to 17:00.

### GUARANTEE

This unit carries a comprehensive UK mainland twelve month/2 year warranty. The guarantee is in addition to, and does not diminish your statutory or legal rights.

The guarantee does not cover:

- Accidental damage, misuse or use not in accordance with the manufacturer's instructions
- Consumable items
- Damage due to incorrect installation, modification, unauthorised service work or damage due to scale, food debris build-up, etc.

The manufacturer disclaims any liability for incidental, or consequential damages. Attendance is based on reasonable access to the appliance to allow the authorised technician to carry out the warranty work.

Service calls to equipment under warranty will be carried out in accordance with the conditions of sale. Unless otherwise specified, a maximum of 15 minutes of administrative time, not spent directly carrying out servicing work, is provided for within the warranty. Any requirement for staff attending the call to spend greater time than 15 minutes due to administrative requirements, such as on health and safety risk assessments, will be chargeable at the prevailing rate.